







NÁVOD K OBSLUZE

LÁMAČKA NA ZÁMKOVOU DLAŽBU RUBI B-13 , B-14

HLAVNÍ CHARAKTERISTIKY

	Ref.						
B-13	05925	31 cm	10,5 cm	28,5 Kg	600x180x600 mm	0-10,5 cm	4100 Kg
B-14	05930	41 cm	14,5 cm	60 Kg	850x250x650 mm	1-14,5 cm	4100 Kg

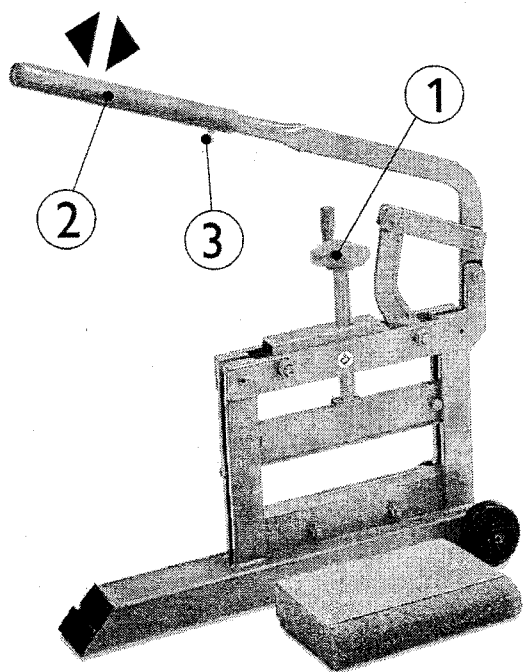

B-13

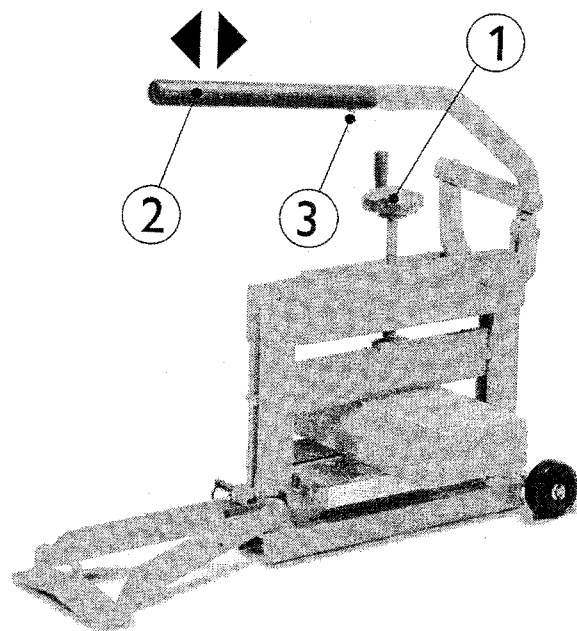

B-14

1. Aretovací šroub pro nastavení výšky nože. Je nutné ho udržovat v čistotě a mazat olejem.
2. Polohovací páka.
3. Aretovací šroub páky.

Lámačka je určená pro lámání zámkové dlažby. Stroj udržujte v čistotě. Po otupení lámacích nožů je nutné nože vyměnit.